

LOW FREQUENCY TUNING FORK RESONATORS (SMD)

SMLF-3215



FEATURES

- Surface Mount
- Surface Mount with Ceramic Package
- Reflow solderable



Item		Specifications
Nominal Frequency Range	f_0	32.768KHz
Frequency Tolerance, $T_a=25^{\circ}\text{C} \pm 3^{\circ}\text{C}$	$\Delta f/f$	$\pm 20\text{ppm}$
Load Capacitance	C_L	12.5pF
Temperature Coefficient	$\Delta f/f$	$-0.034 \pm 0.006\text{ppm}/^{\circ}\text{C}^2$
Operating Temperature Range	T_{OPR}	$-10^{\circ}\text{C} \sim +70^{\circ}\text{C}$
Storage Temperature Range	T_{STG}	$-55^{\circ}\text{C} \sim +125^{\circ}\text{C}$
Drive Level	DL	0.1mW (0.5mW Max.)
Series Resistance (ESR)	R_1	70K Ω Max.
Insulation Resistance	IR	500M Ω Min.
Aging	Δf_A	$\pm 5\text{ppm}/\text{Year Max.}$

Please consult our sales representatives for other specifications.

DIMENSION (mm)

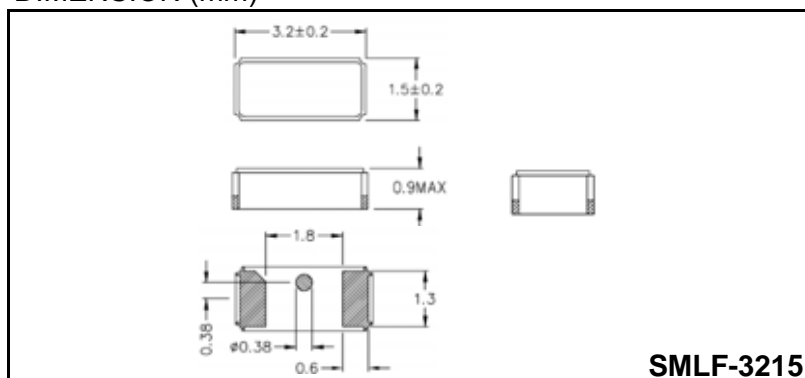

All specifications are subject to change without notice.

SOLDERING PATTERN (mm)

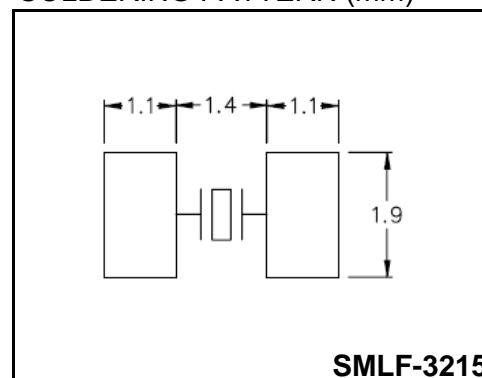

Interquip Electronics Co., Ltd

Flat A, 9/F, On Shing Industrial Building, 2-16 Wo Liu Hang Road, Fotan, Hong Kong
 Tel: +852 2413 5515 Fax: +852 2413 7053 <http://www.interquip.com>